

基礎CD1
*基礎CD1施工は現場打ちとしスリーブ抜きを行わないで下さい。

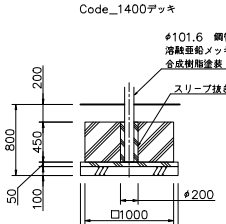

基礎CE1

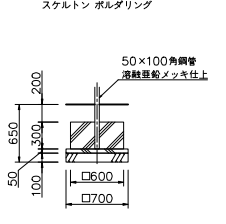

基礎CG1

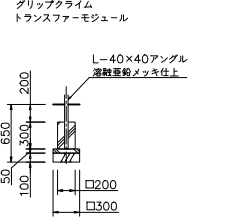

基礎CH1

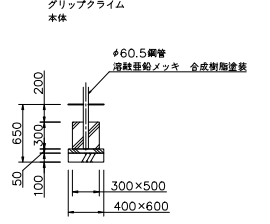

基礎CH2

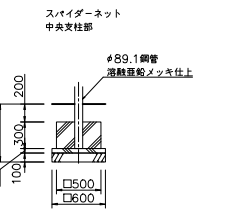

基礎CJ1

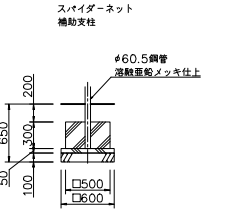

基礎CJ2

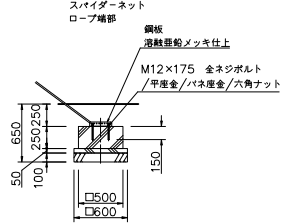

基礎CJ3

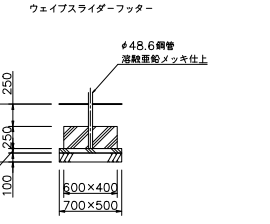

基礎Y2
*基礎Y2施工は現場打ちとしスリーブ抜きを行わないで下さい。

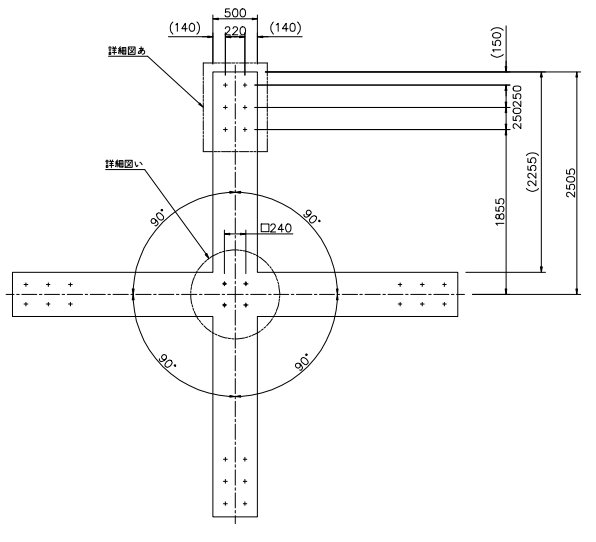

基礎CB1 (平面)

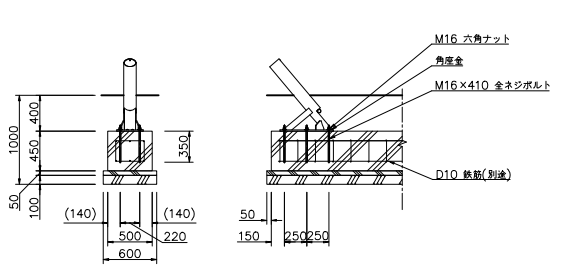

基礎CB1 詳細図め

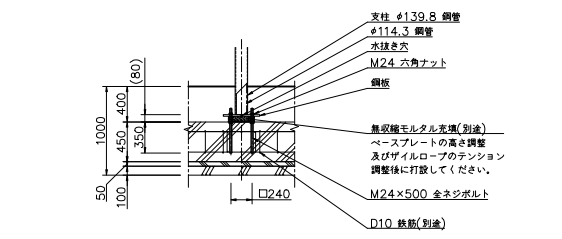

基礎CB1 詳細図い

基礎詳細図 S=1/30

△				
△				
△				
△				

KOTOBUKI CORPORATION

PROJECT	プレイコード	DATE	2024/10/21	SCALE	1/50	FILE NO.	
DRAWN	鈴木 (誠)	CHECKED	山浦	APPROVED	中村 (弘)		
DWG NO.	CP-02803 (基礎図)						EP01991-B